

C6 RANGE

114 x 162 wallets

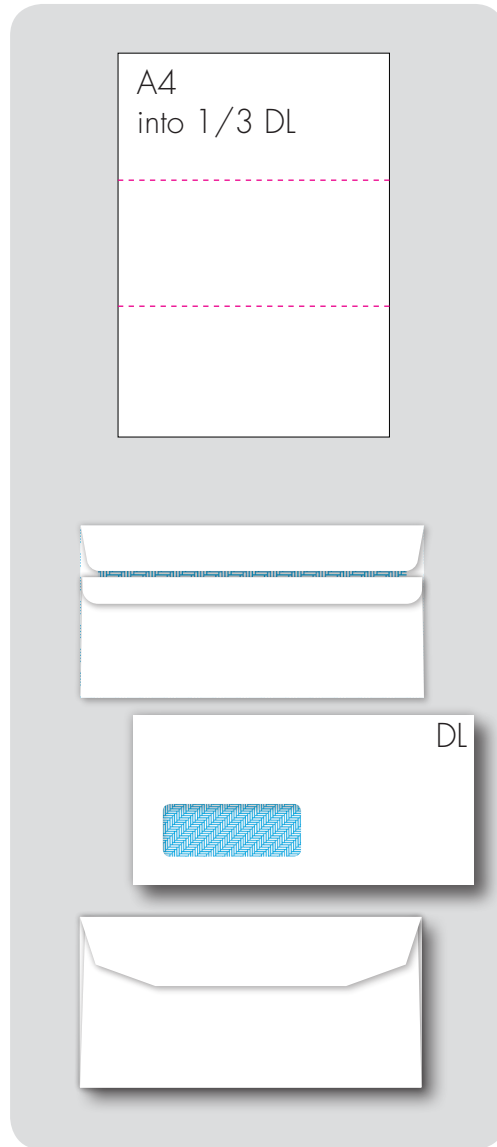

DL RANGE

105 x 216 wallets 114 x 235 wallets
110 x 220 wallets 121 x 235 wallets
114 x 229 wallets

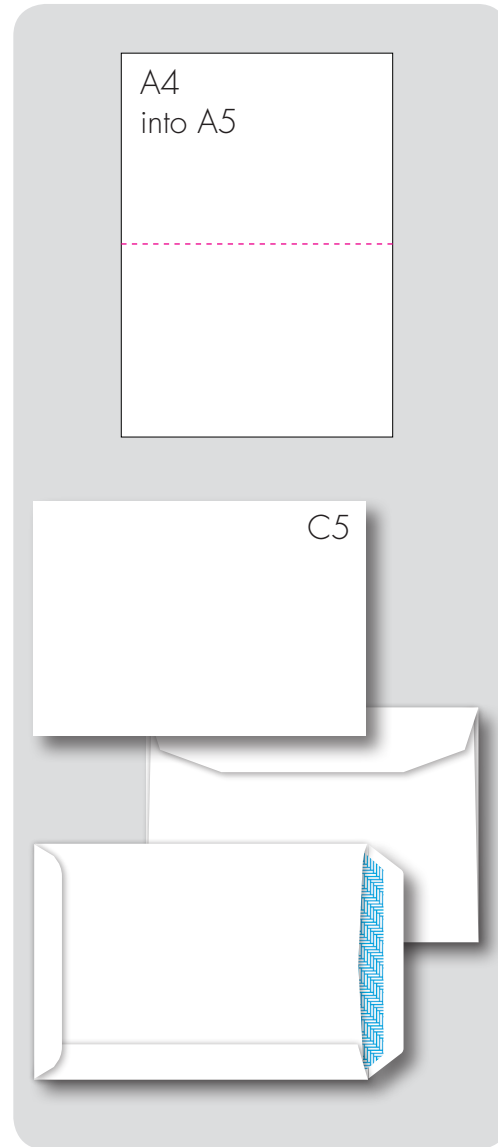

C5 RANGE

155 x 220 wallets 162 x 238 wallets
162 x 229 wallets 162 x 240 wallets
162 x 235 wallets 229 x 162 pockets

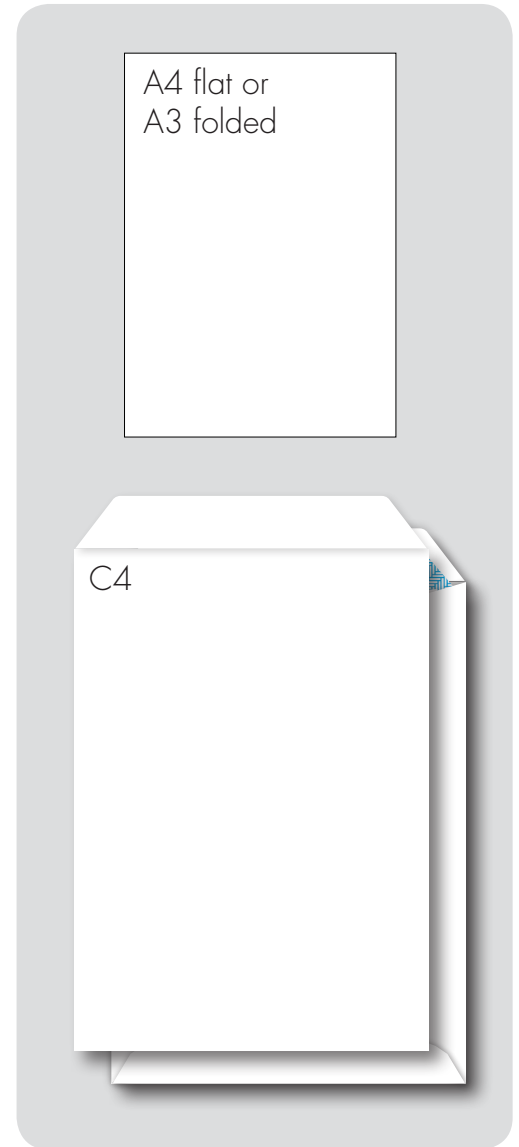

C4 RANGE

229 x 324 wallets
324 x 229 pockets

We make a comprehensive but concise range of the most popular envelopes used in the workplace in today's modern business environment which are used for a range of commercial business applications.

Whether you want them supplied printed or plain our range consists of wallets and pockets offered in many of the most popular paper grades to suit the office environment.

Wallets - Open on long edge.

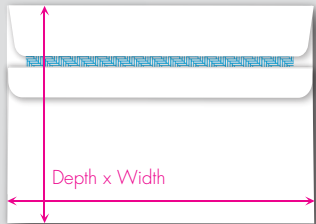

Pockets - Open on short edge.

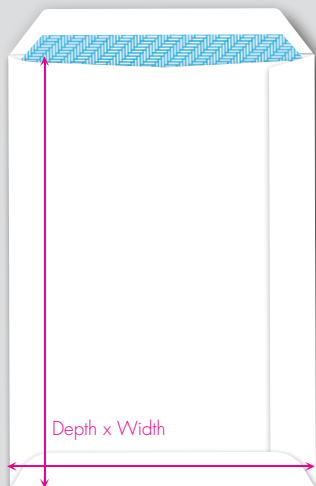

Measuring Windows

Wallets or Pockets, measure with the flap positioned at the top.

Measure as follows:

Window Depth x Width

Position up from foot (up)

Position in from left (flhs)

Example: 45 x 90, 60up, 20flhs

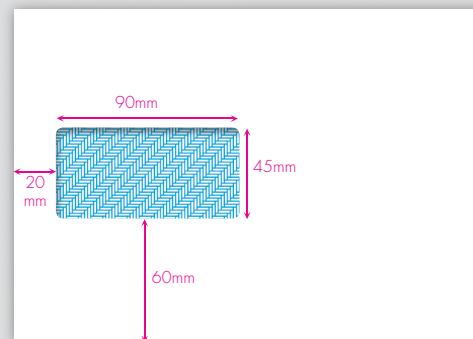

Gummed

Apply water to activate the flap adhesive. This is the strongest and most secure way of sealing envelopes.

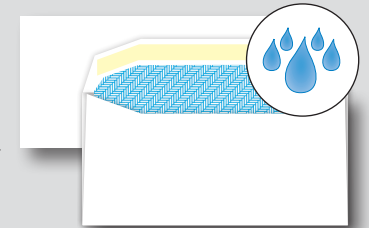

Self Seal

A user friendly sealing method to avoid the use of water. Close the envelope and press the flaps firmly from side to side to activate the flap adhesive to seal the envelope.

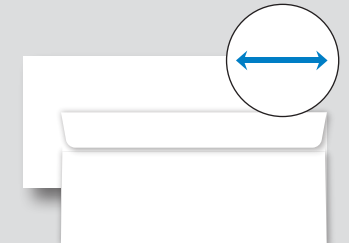

Peel & Seal

Increasingly popular way of sealing the envelope. Simply peel back the protective paper strip and close the flap, pressing firmly from side to side to activate flap adhesive. The paper strip keeps adhesive fresh and ready for use.

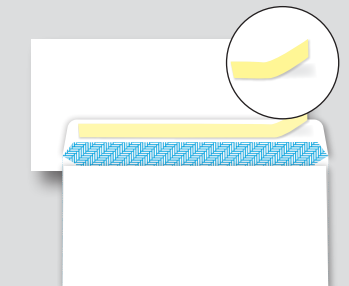

Inserting Machine Envelopes

Specifically designed to work on envelope inserting machines.

We have a stock range available for immediate delivery or we can make and print your envelopes to your specifications.

So whether you need a business reply envelope or an outer envelope then just ask and we will look to see if we can make it for you?

- **Trapezoid flap shape**
designed for inserting machines
- **Inside & outside side-seams**
side seams to suit your model of inserting m/c
- **Standard size or oversized options**
to accommodate a reply envelope
- **PVA gummed flap**
for a quick drying seal
- **White and manilla paper options**
- **PEFC certified white as standard**
throughout the range so you can be sure you are using envelopes made of paper from responsible forest managed sources
- **Printed security opaque**
to protect the identity of the contents
- **Customised printing service**
- **Standard sized windows**
or we can manufacture a bespoke window size & position to suit your requirements.

